

*Spare parts suitable for:*  
**SAN MARCO**

*Spare parts suitable for coffee machines*



## Solenoid valves

Scem/Parker



Item	Order	Description
1	370057	cpl., 3 ways, 230V AC
2	370062	Solenoid square base, 3 ways
3	370206	cpl., 1/8", 2 ways, 230V AC
3	370067	cpl., 1/4", 2 ways, 230V AC
4	371029	Magnetic coil, 230V AC

Lucifer



Item	Order	Description
1	370053	cpl., 3 ways, 230V AC
2	370061	Solenoid square base, 3 ways
3	370072	cpl., 1/8", 2 ways, 230V AC
3	370088	cpl., 1/4", 2 ways, 230V AC
4	371031	Magnetic coil, 230V AC

## Pressure switch

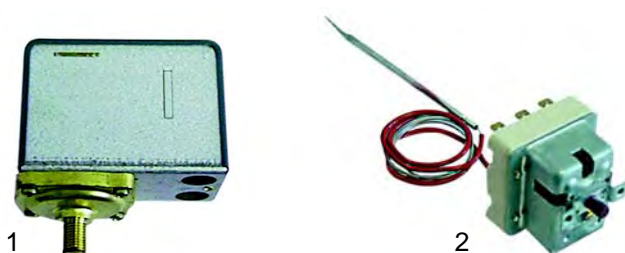

Item	Order	Description
1	541021	Pressure switch
2	390324	Safety thermostat

## Switches

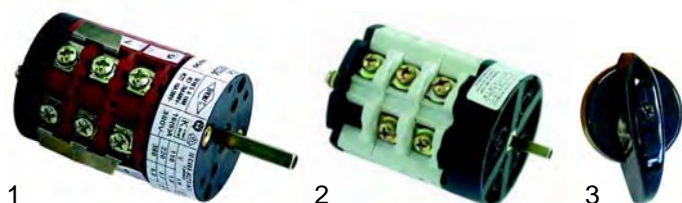

Item	Order	Description
1	345145	Main switch
2	345114	Main switch
3	111012	Knob

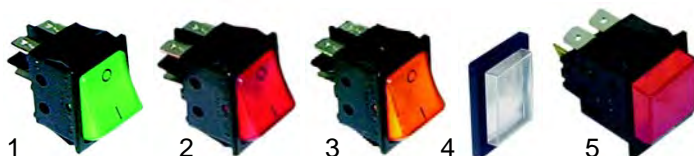

Item	Order	Description
1	301003	Switch, 2 poles, 30 x 22 mm
2	301001	Switch, 2 poles, 30 x 22 mm
3	301018	Push button, 2 poles 30 x 22 mm
4	301036	Protective cover
5	345098	Push button, 2 poles, 27,2 x 22,2 mm



Item	Order	Description
1	345103	Microswitch
2	346072	Microswitch

## Level controller



Item	Order	Description
1	400230	Level controller (RL40/1E/11), 230 V
2	400017	Level controller (RL30/1E-2C/11), 230 V
3	380136	Base, 11 poles

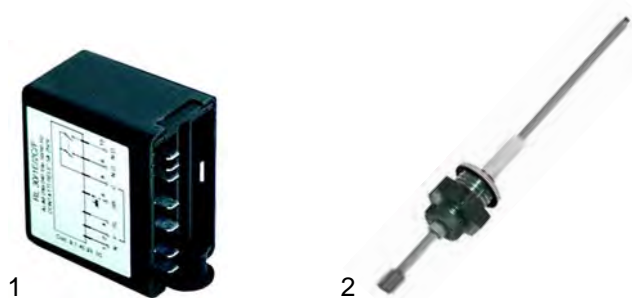

Item	Order	Description
1	400019	Level controller (RL30-1E-2C/F), 230 V
2	400020	Level probe, 150mm

## Flowmeter



Item	Order	Description
1	400222	Flowmeter, 1/4"
2	400004	Flowmeter, 1/4"
3	400256	Plug
4	400257	Flowmeter turbine
5	400258	Case gasket

## Key push buttons



Item	Order	Description
1	400488	Key push button/cpl., 1 group
1	400489	Key push button/cpl., 2 - 4 groups
2	400343	Push button panel

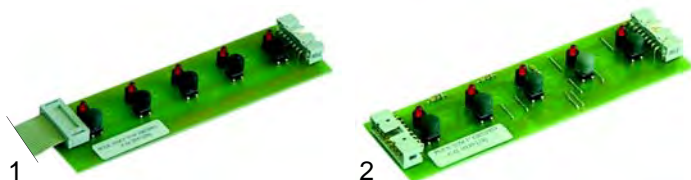

Item	Order	Description
1	400490	Key push button/right
2	400491	Key push button/left

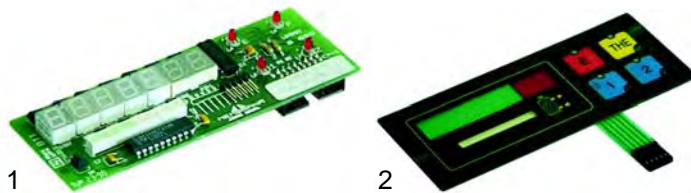

Item	Order	Description
1	400492	Key push button board
2	400493	Push button panel

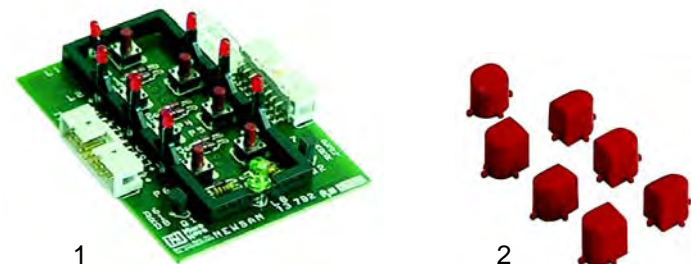

Item	Order	Description
1	400494	Key push button/coffee
2	400495	Push button set/coffee

## Key push buttons



Item	Order	Description
1	400496	Key push button/water
2	400497	Push button/water with indicator
3	400498	Key push button/water with indicator

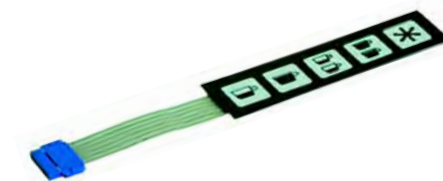

Item	Order	Description
1	400334	Push button panel

## Elements



Item	Order	Description
1	417023	1 group, 1750W, 230V
2	417024	2 groups, 2 circuits, 2600W, 230V
3	417140	3 groups, 2 circuits, 4000W, 230V

## Elements



Item	Order	Description
1	417025	2 groups, 3 circuits, 2600W, 230V
1	417028	2 groups, 3 circuits, 3000W, 230V
2	417141	3 groups, 3 circuits, 4500W, 230V
3	528010	Element gasket (teflon)
4	528304	Element gasket (klingerit)

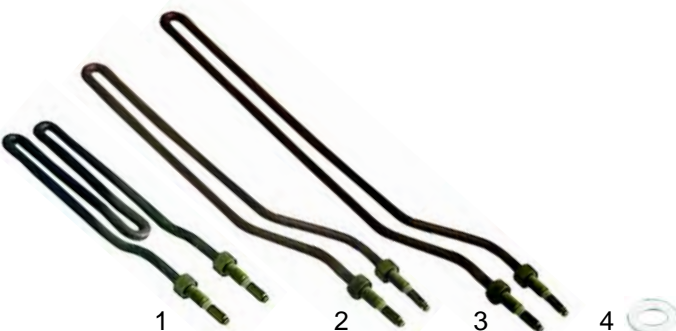

Item	Order	Description
1	417026	1 groups, 1000W, 230V
2	417027	2 groups, 1300W, 230V
3	417142	3 groups, 1850W, 230V
4	528011	Element gasket

## Elements



Item	Order	Description	Model
1	417185	(PRATICAL), 1 group, 2000W, 230V	
2	417029	(Sprint), 2 groups, 3000W, 230V	
3	417186	(Sprint), 3 groups, 4500W, 230V	
4	510459	Element gasket	
5	528857	Element gasket (teflon)	

## Boiler gaskets



Item	Order	Description
1	528133	Boiler gasket (teflon), 165 x 150 x 3 mm
2	528858	Boiler gasket (teflon), (Sprint)

## Manometers



Item	Order	Description
1	541220	Manometer/doublescale
2	541244	Manometer/doublescale, 0 - 3 bar

## Valves



Item	Order	Description
1	529312	Safety valve, 1,8 bar, 3/8"
2	529316	Safety valve/sealed, 1,8 bar, 3/8"
3	529309	Safety valve, 1,8 bar, M18 x 1,5
4	529349	Cu-gasket, 3/8"



Item	Order	Description
1	529303	Empty valve, 1/4"
2	529361	Cu-gasket, 1/4"
3	528790	Retention valve, 3/8"



Item	Order	Description
1	529554	Valve/cpl.
2	528206	O-ring
3	528282	O-ring
4	528859	Washer
5	528860	Spring

### Drain sump



Item	Order	Description
1	529751	Drain sump

### Level glass

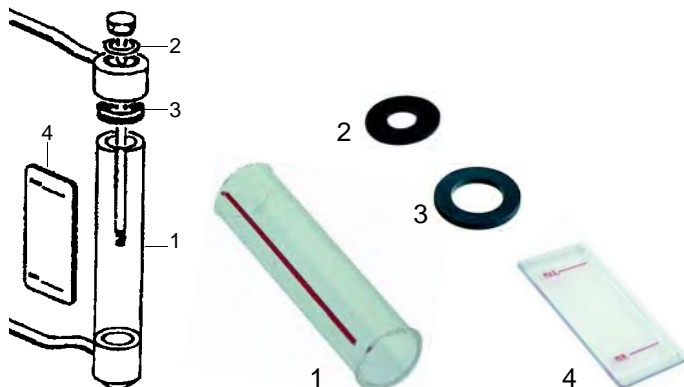

Item	Order	Description
1	529390	Level glass, 30 x 110mm
2	529392	Gasket
3	529391	Level glass gasket
4	528861	Screen (Plastic)

### Water inlet valve



Item	Order	Description
1	529551	Water inlet valve
2	528862	Lever
3	111051	Handle
4	528863	Lever
5	111052	Handle
6	528864	Lever
7	111010	Handle

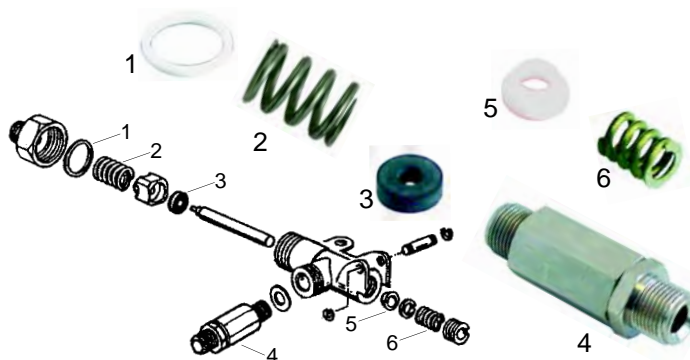

Item	Order	Description
1	528865	Gasket
2	528866	Spring
3	528302	Gasket, 15 x 5,5 x 4mm
4	528790	Retention valve/cpl.
5	528867	Gasket (teflon)
6	528307	Spring

### Taps



Item	Order	Description
1	529834	Steam and water tap/cpl.
2	529550	Steam and water tap/cpl.
3	529835	Steam and water tap/cpl.

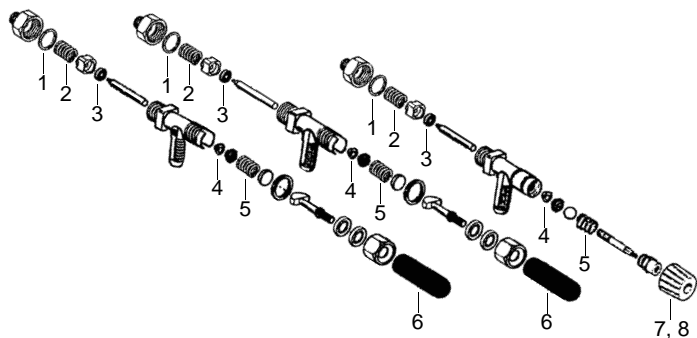

Item	Order	Description
1	528865	Gasket
2	528868	Spring
3	528302	Gasket
4	528303	Gasket (teflon)
5	528869	Spring
6	111037	Handle, M10
7	111038	Knob/grey
8	111039	Knob/black

## Delivery pipes



Item	Order	Description
1	529553	Steam pipe
2	529556	Water pipe
3	528207	Gasket (teflon)
4	528869	Spring
5	529552	Steam pipe
5	529836	Steam pipe (stainless steel)
6	529555	Water pipe
7	528307	Spring
8	528306	Washer
9	528208	Gasket (teflon)
10	528305	Union nut

Group

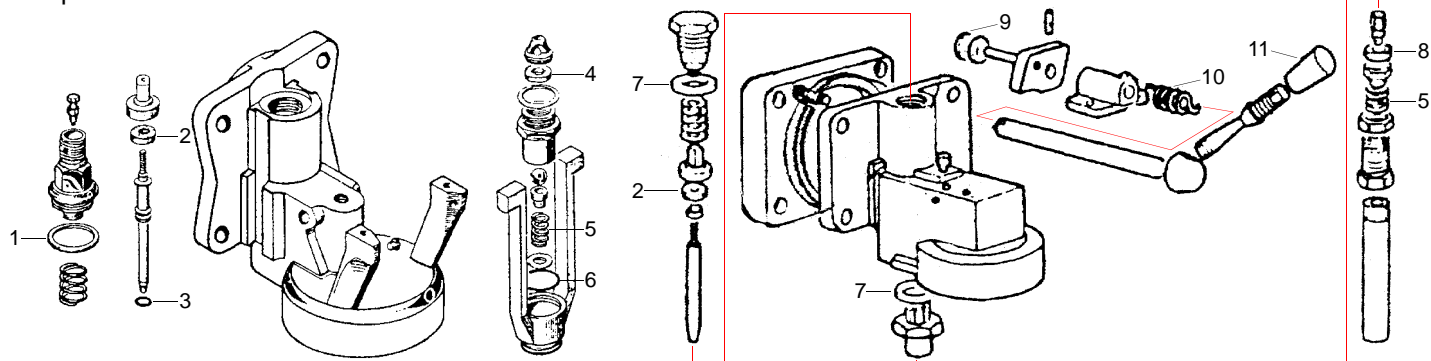

Manual

NS 85



Item	Order	Description	Item	Order	Description	Item	Order	Description
1	528834	Gasket	5	528873	Spring	9	528875	Wheel
2	528870	Gasket, 16,5 x 5 x 4 mm	6	528455	O-ring	10	528876	Spring
3	528871	O-ring	7	528874	Gasket	11	111056	Handle
4	528872	Gasket	8	528494	Gasket			

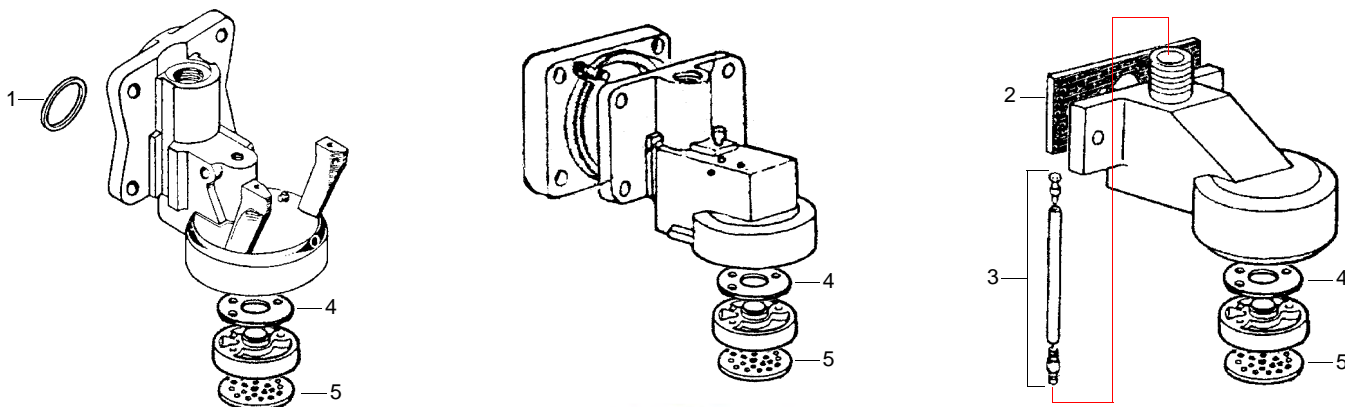

Item	Order	Description	Item	Order	Description	Item	Order	Description
1	528136	O-ring	3	528227	Jet/cpl., 3 components	5	529088	Shower
2	528877	Gasket	4	528878	Shower holder gasket			

Filter holder gaskets, filters



Item	Order	Description	Item	Order	Description
1	528048	Shim gasket, 63 x 53 mm	4	529027	Filter, 2 cups (14g)
2	528038	Filter holder gasket, 64 x 52 x 5,5 mm	5	529028	Blank filter
2	528041	Filter holder gasket, 64 x 52 x 6,5 mm	6	529079	Filter holder spring
3	529026	Filter, 1 cup (7g)			

## Filter holders



Item	Order	Description
1	529057	Filter holder, 3/8", M10

Item	Order	Description
2	529053	Filter holder handle

## Spouts



Item	Order	Description
1	529002	3/8", 1 way, straight/short
2	529001	3/8", 1 way, straight/long
3	529005	3/8", 1 way, curved/short
4	529003	3/8", 1 way, curved/long

Item	Order	Description
5	529004	3/8", 1 way, curved/closed
6	529008	3/8", 2 ways, distance 44 mm
7	529007	3/8", 2 ways, distance 55 mm/short
8	529006	3/8", 2 ways, distance 55 mm/long